

BASO 4.0 DIRECT

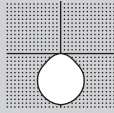

PERFORMANCE

- Up to 111lm/W efficiency
- 500 / 955 lm/ft
- CRI > 80 & CRI > 90
- IC & Damp rated



MOUNTING

Recessed

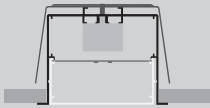

PATTERNS



*X Shapes



Angles



*Wall to Ceiling



Rectangles



*T Shapes

For customization, please contact customer service

FIELD-CUTTABLE FLEX

Down to 1/16"



[link to video](#)

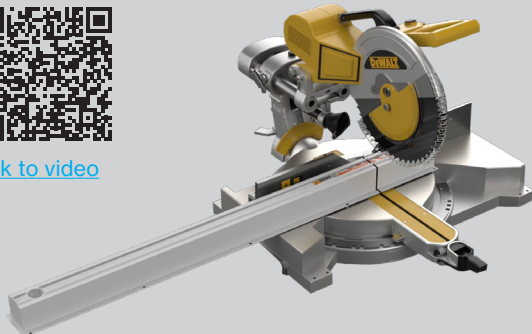

Catalog Number Example

BASO 4.0-RTR-BL-OP-30K-C80-UNV-010V-SEN-955LF-NLC-ST-96IN-CCEA

A RANGE

BASO 4.0 BASO4 . 0

B MOUNTING

CS Recessed trimless	R T L
CS Recessed with trim	R T R
CS Armstrong Suprafine 9/16" G	A 9 G
CS Armstrong Interlude 9/16" SG	A 9 S
CS Armstrong Silhouette 9/16" BSG	A 9 S
CS Armstrong Prelude 15/16" G	A 1 5
CS 9/16" Grid (any brand)	9 G R
CS 9/16" Slot Grid (any brand)	9 S G
CS 15/16" Grid (any brand)	1 5 G
Custom	X X X

C COLOR

CS White	W H
CS Black	B L
Gray	G R
Custom color RAL	X X

trimless version available in white only

D LENS

HP opal cover O P

E CCT

2700K	2 7 K
CS 3000K	3 0 K
CS 3500K	3 5 K
4000K	4 0 K

F CRI

CRI > 80	C 8 0
CRI > 90	C 9 0

G VOLTAGE

120V/277V U N V

H DIMMING

CS 0-10V 1%	0 1 0 V
Lutron EcoSystem	L E S 1
Quantum, Vive, GRAFIK Eye, HomeWorks	
Power over ethernet	P O E C
consult customer service for compatibility	
Custom dimming	X X X X
consult customer service for compatibility	

I SENSOR (optional)

Integrated Sensor S E N
consult customer service for sensor request

J OUTPUT LM/FT

CS 500lm/ft 100% ↓	0 5 0 0 L F
CS 750lm/ft 100% ↓	0 7 5 0 L F
CS 1000lm/ft 100% ↓	1 0 0 0 L F
Custom lm/ft	X X X X L F

custom lumen up to 1400 lm/ft

K CIRCUIT / EM

CS Single circuit	*
EMC night light circuit	N L C
EMB available in 4ft and 8ft	E M #

* leave blank

L SHAPE / PATTERN

CS Linear / straight	S T
Linear / straight + flex inset	S F
includes 4ft. field-cutable section	
L-shape	L S
□-shape (rectangular shape)	R S
U-shape	U S
Custom shape	X X

for grid applications using L-shape, rectangular shape or U-shape, please contact customer service for availability

M DIMENSIONS IN INCH

Linear 2'	2 4 I N
CS Linear 4'	4 8 I N
CS Linear 6'	7 2 I N
CS Linear 8'	9 6 I N
Linear custom	## # I N
Linear flex inset	## # I N
field-cutable section	
L-Shape	## # X ## # I N
U-Shape	## # X ## # X ## # I N
□-Shape	## # X ## # I N



for lengths including flex insets, round up to the nearest total foot length

N CERTIFICATION (optional)

Chicago Plenum	C C E A
Red List Approved	R L A

BASO
basolighting.com
xalusa.com

Technical data

	SIZE TYPE	LED COLOR TEMPERATURE	INPUT WATTS	DELIVERED LM TOTAL	LIGHT DISTRIBUTION	DELIVERED LM DIRECT	DELIVERED LM INDIRECT	OPTICAL EFFICIENCY	LUMINAIRE EFFICACY	
BASO DIRECT										
	e LED	2' linear	40K	9W	910lm	100% down	500 lm/ft	-	76%	111lm/W
		4' linear		18W	2000lm					
		6' linear		27W	3000lm					
		8' linear		36W	4000lm					
		2' + 2' corner		18W	2000lm					
	e² LED	2' linear	40K	18W	1910lm	100% down	955 lm/ft	-	76%	106lm/W
		4' linear		36W	3820lm					
		6' linear		54W	5730lm					
		8' linear		72W	7640lm					
		2' + 2' corner		36W	3820lm					

for 30K or 35K multiply lm value by 0.96

Patterns top view

LINEAR

A	FIXTURES	CODE
48"	1 × 4' linear	ST - 0 4 FT
96"	1 × 8' linear	ST - 0 8 FT
144"	3 × 4' linear	ST - 1 2 FT

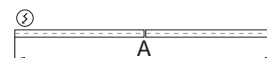

L-SHAPE

A / B	FIXTURES	CODE
48" / 48"	2 × 2' linear + 1 × 2' × 2' corner	LS - 0 4 X 0 4 FT
48" / 96"	1 × 2' linear + 1 × 6' linear + 1 × 2' × 2' corner	LS - 0 4 X 0 8 FT
96" / 96"	2 × 6' linear + 1 × 2' × 2' corner	LS - 0 8 X 0 8 FT

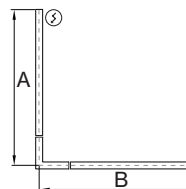

□-SHAPE (rectangular shape)

A / B	FIXTURES	CODE
48" / 48"	4 × 2' × 2' corner	RS - 0 4 X 0 4 FT
48" / 96"	2 × 4' linear + 4 × 2' × 2' corner	RS - 0 4 X 0 8 FT
96" / 96"	4 × 4' linear + 4 × 2' × 2' corner	RS - 0 8 X 0 8 FT

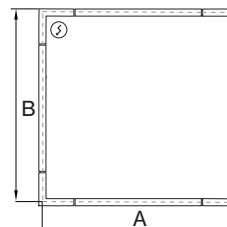

U-SHAPE

A / B / C	FIXTURES	CODE
48" / 48" / 48"	2 × 2' linear + 2 × 2' × 2' corner	US - 0 4 X 0 4 X 0 4 FT
48" / 96" / 48"	1 × 4' linear + 2 × 2' linear + 2 × 2' × 2' corner	US - 0 4 X 0 8 X 0 4 FT
48" / 144" / 48"	1 × 8' linear + 2 × 2' linear + 2 × 2' × 2' corner	US - 0 4 X 1 2 X 0 4 FT

